



XNAV3500P PORTABLE GPS NAVIGATION SYSTEM

QUICK START GUIDE





TABLE OF CONTENTS

	Page
Preface	1
Safety Information/Precautions	2
Introduction	3
Package Contents	4
Control Locations	5
Getting Started	6
Main Menu Screen	7
Transferring Files	12
Pre-loaded Maps	13
Alternate Maps	14
Navigation Overview	15
Starting Navigation	17
Entering Addresses	19
Selecting Points of Interest	19
Searching	24
Additional Functions	26
Warranty	28
Battery Information	29

Preface

The XNAV3500P combines state-of-the-art turn-by-turn navigation with a built-in multimedia player. Before operating, take a few minutes to review the safety and operating instructions in this Quick Start Guide so you can quickly and safely become familiar with its many features.

This Quick Start Guide explains the system functions, and provides details on:

- Safety information
- Control locations
- Setting up the unit
- Basic navigation functions
- Multimedia functions
- System preferences

For detailed navigation functions and operation, please refer to the full-length owner's manual included in .pdf format on the DVD-ROM.

IMPORTANT NOTES:

This unit includes an internal Li-ion battery, and should be fully charged prior to first operation. This unit is shipped in "full power off" mode. To activate the unit for first time use:

- Insert SD memory card
- Press the RESET button located on the left side of the unit

To return the unit to "full power off" mode, press and hold the RESET button for 3 seconds. The clock settings and GPS signal information is erased when the unit is in "full power off" mode.

To turn the unit on/off normally, press the power button momentarily.

When turned on for the first time (or if the unit has been idle for several days, or been moved more than 250 miles while off), it can take several minutes to acquire a GPS signal. GPS signal acquisition times will be typically less than a minute when the unit is turned on again.

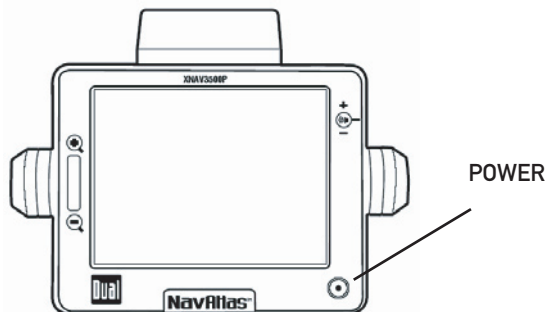
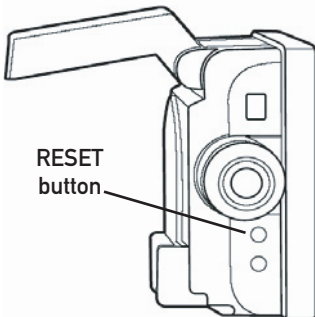



Safety Information and Precautions

WARNING! PLEASE READ AND FOLLOW THE FOLLOWING SAFETY PRECAUTIONS. FAILURE TO FOLLOW THE INSTRUCTIONS BELOW MAY INCREASE YOUR RISK OF COLLISION AND PERSONAL INJURY.

The warning screen is displayed each time the Navi Icon is selected as a reminder to make use of the system's navigational aids in a safe manner. Before using the XNAV3500P, read this entire Quick Start Guide. Make sure that you are familiar with the features and know how to operate the system.

Proper use of the XNAV3500P includes the following guidelines: The navigation system is not a substitute for your personal judgment. The route suggestions should never supersede any local traffic regulation or your personal judgment and /or knowledge of safe driving practices. Prior to completing any maneuvers suggested by your navigation system (for example, a U-turn or a left turn), verify that you can legally and safely complete the maneuver. Do not follow route suggestions if they direct you to perform an unsafe or illegal maneuver, would place you in an unsafe situation, or would route you into an area that you consider unsafe. Glance at the screen only when necessary and safe to do so. Let the voice guide you. If prolonged viewing is necessary, pull off the road to a safe location.

The database may not include all emergency service providers. Use your own best judgment and ask for directions in these situations. If the vehicle is in motion, only a passenger should program the unit. The driver should not program the unit unless the vehicle is parked in a safe location. The map database provides information on suggested routes without regard to factors that may affect your driving experience or the time required to arrive at your destination. For example, the system does not reflect road detours, closures or construction, some road characteristics (e.g., road surface, slope or grade, weight or height restrictions, etc.), temporary traffic congestion, weather conditions, and similar factors.

Introduction to your Navigation System

As you travel, your navigation system functions as your co-pilot, providing turn-by-turn visual and voice assistance to direct you to your selected destination. Because the system knows where you are and where you want to go, it can quickly calculate step-by-step directions that provide a route to any destination available on the included navigation map. The map includes millions of roadway and mapping destinations, and pre-programmed point of interest (POI) locations in several different categories. Simply enter your desired destination into your navigation system, and its advanced intelligence does the rest.

With your navigation system, if you deviate from the planned route, the navigation system will automatically recalculate the route to determine a new one from your current location.

The navigation system uses Global Positioning System (GPS) satellites, and a digital roadway map database to calculate and display travel directions. The system's GPS antenna receives signals from a constellation of 24 satellites orbiting the earth and uses the strongest of signals to determine your position to within meters. The navigation system's sophisticated software provides the highly accurate positioning necessary to provide real-time, accurate, turn-by-turn route guidance.

Vehicle Position

The navigation system's computer considers vehicle speed and heading changes, together with longitude and latitude information, to accurately determine vehicle heading and position on a digital map. This information is relayed to you as you proceed to your selected destination through audible suggestions, turn symbols, and the on-screen map.

Signals from GPS satellites are used to determine the vehicle location. Three (good) or four (best) satellites must be received to accurately determine location. The GPS reception status is indicated by the GPS satellite indicator on the map. See the GPS indicator section on page 16 for more information.

Map and Information Database

The map database used by your navigation system was created using high-resolution aerial and land based data collection and is stored on a memory card. This data is enhanced with useful travel information, such as freeway signage and approximately two million points of interest locations in several different categories, such as tourist attractions, gas stations, airports, and restaurants. While the database was judged to be as accurate as possible at the time of its release, a map database can never be 100% accurate. Road information that is maintained in the map databases, such as turn restrictions or road names, may change over time. In addition, points of interests, such as restaurants, hotels, and gas stations, also change over time. The complexity of keeping this directory current means that some information may be missing or out-of-date at times.



XNAV3500P PORTABLE GPS NAVIGATION SYSTEM

Package Contents



XNAV3500P



1GB SD Memory Card

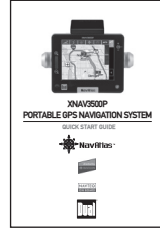

Quick Start Guide



12VDC Adapter



USB Cable



Windshield Mount



**Microsoft® ActiveSync®
Software Disc**



Map Database DVD-ROM



Stylus



Carry Bag

Control Locations

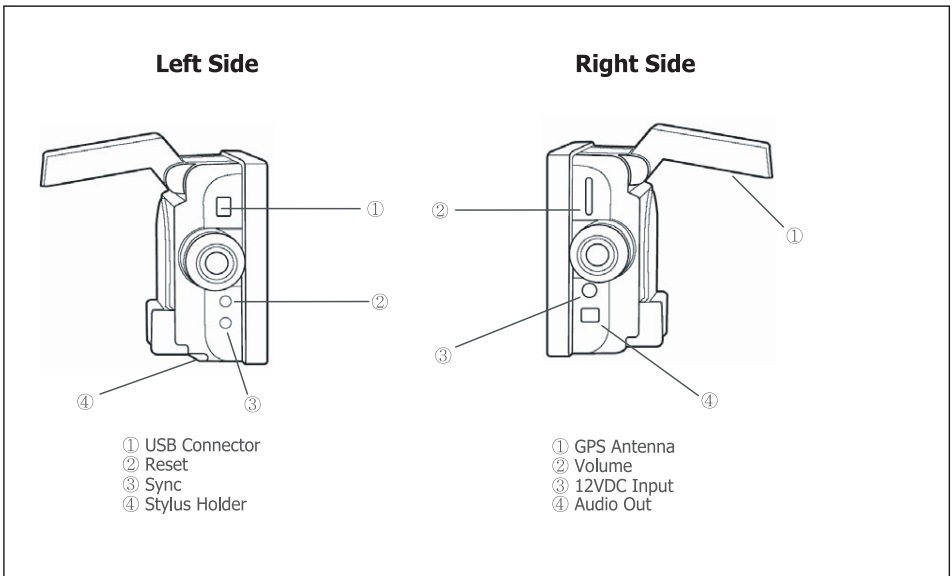
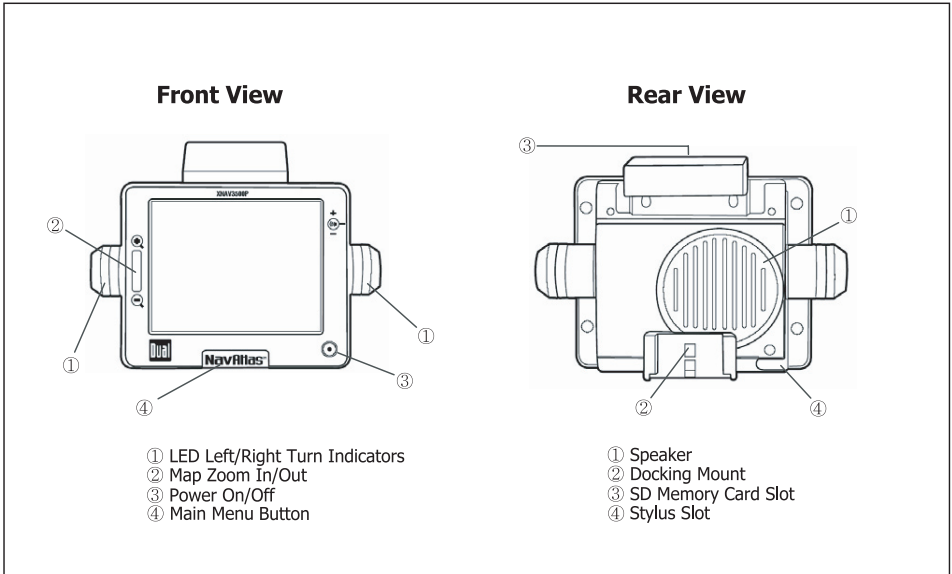



Getting Started

Inserting an SD Card

Your device has an SD card slot located in the top of the unit. Digital maps and other data including MP3 files, .avi files and image files can be added. To use the memory card, insert it with the connector pointing down into the slot, and the label facing the front of the device. To remove the card, power off the unit, slightly push down on the top of the card to release it, then pull it out of the slot.



Mounting and Connecting Power



1. First, clean the windshield. Then push the center of the suction cup onto the windshield before pressing the suction lever down.

2. Slide the rectangular head of the suction cup mount into the corresponding mount at the bottom rear of the unit.

3. Connect the supplied DC power adapter to the 12VDC connector located on the right side of the unit. Plug the other end into a standard vehicle cigarette outlet to charge the internal battery.

Main Menu Screen

Overview

When you turn on the XNAV3500P the main menu screen appears as shown below. At the top right corner is a battery status indicator, indicating the actual percentage of charge remaining. The time is shown in the top left corner.

On the main menu, you will find the six modes of operation (NAVI, MUSIC, MOVIE, PICTURE, GPS and BRIGHTNESS). By tapping on the down arrow on the right, two more modes (TIME SET, & CALIBRATE) appear.

Each button represents a software function (NAVI, MUSIC, MOVIE or PICTURE) or a user setup function (GPS, BRIGHTNESS, TIME SET, or CALIBRATE). To access any of the modes, just tap the corresponding icon. Press the NavAtlas button to return to the main menu.





Navigation

This function guides you to your destination using voice prompts and mapping, showing crossroads, city names and much more. It also provides various map-guiding modes and the approximate time left until you arrive at your destination. For your safety, it also lets you know when to make a turn by blinking LEDs on the left/right side.

Touch the 'NAVI' icon on the main menu screen, and wait for the navigation program to load all the necessary data. For instructions on basic navigating, skip to page 17.



Music

Want to listen to your favorite music on the go? Since the XNAV3500P includes a built-in MP3 player, just download and save your favorite MP3s to the root folder of any SD card and play.

Touch the 'MUSIC' icon on the main menu screen. Once the MP3 player skin loads, the screen will display a playlist from which you can select a specific music track. You can also use the slide control at the lower right to select a specific point of the track.

Additional buttons are visible in the lower section of the player skin, including rewind, play/pause, and repeat. Press the NavAtlas button to return to the main menu.

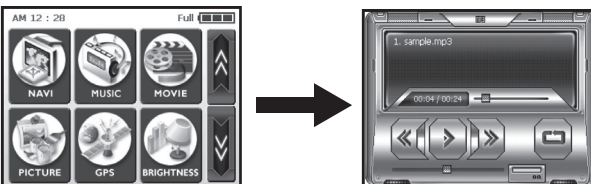

IMPORTANT NOTE: Multimedia functions are not accessible during navigation.

Movies

The XNAV3500P includes a built-in video player. Download and save your favorite .avi video files to the root folder of any SD card, then enjoy them on the XNAV3500P. Touch the 'MOVIE' icon on the main menu screen. Once the movie player skin loads, the screen will display a playlist from which you can select a specific movie file. A movie file can also be selected using the 'up/down' arrow buttons. Simply tap the 'Play' button at the bottom center.

During video playback, if you want to go back to a specific point, touch the screen, and it will freeze to allow you to move the slider along the bottom to a specific part of the movie. Touching the screen again will resume playback. Press the NavAtlas button to return to the main menu.



IMPORTANT NOTE: Movies are best viewed at 320 x 240 resolution.

Pictures

The XNAV3500P includes a built-in image viewer. Download and save image files to the root folder of any SD card, then view them on the XNAV3500P. Touch the 'PICTURE' icon on the main menu screen.

Once the image viewer skin loads, you will see a frame with an image on the left and various buttons to the right. The left arrow goes back to the previous image while the right arrow advances to the next image. If you want to view a picture in full screen mode, touch the screen anywhere on the image, and it will automatically enter the full screen mode. The '+' button adds the currently viewed image to your photo album, and the 'My' button takes you to the photo album. The photo album viewer changes images every 5 seconds - creating a slideshow effect. In the photo album screen, the 'X' button deletes the image from the album and the double right arrow enters full screen mode. Press the NavAtlas button to return to the main menu.



IMPORTANT NOTE: Images are best viewed at 320 x 240 resolution.



GPS

If the navigation appears to be unstable or erratic, check the satellite acquisition signal strength received by the GPS antenna. You can also reset the GPS receiver by going into the 'GPS' menu from the main menu screen and pressing 'RESET'.

Touch the 'GPS' icon on the main menu screen. Once in the GPS diagnostic screen, 'State' displays the overall performance of the GPS antenna in terms of acquiring satellite signals. V indicates failure, and 2D/3D indicates the performance is satisfactory for navigating. 'Satellite' indicates which satellite signals are being acquired from all that are available. PDOP (Positional Dilution of Precision), HDOP (Horizontal Dilution of Precision), and VDOP (Vertical Dilution of Precision) indicate the accuracy of the acquired signal. At the bottom, cells with unique numbers represent the satellites, and graphic bars show the current detailed status in obtaining a signal from each satellite. Press the NavAtlas button to return to the main menu.

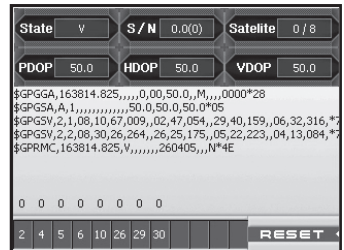

Brightness

The XNAV3500P brightness is set to a default setting of high. You may select another level by using any of three available brightness settings.

Touch the 'BRIGHTNESS' icon on the main menu screen. Three icons will appear, each indicating a different level of brightness. The one at the left provides the darkest LCD, the middle gives a moderately lit LCD, and the right produces the brightest LCD screen. Tap the desired level to change the brightness. Touch the 'OK' button to exit, or undo the change by tapping 'Cancel'.



IMPORTANT NOTE: The brightness setting defaults to high every time the unit is plugged directly into 12VDC.

Time Set

To set the time, touch the 'TIME SET' button on the main menu screen. See page 7 for additional information on accessing the time set screen.

You will see up/down arrows over/under the first set of double figures; these will increase or decrease the 'hours.' Up/down arrows over/under the next two single-digit figures adjust the minutes. A small AM/PM section is at far right; touching it will toggle between the two. Touch the 'OK' button to save the time and exit, or undo the change by tapping 'Cancel'.

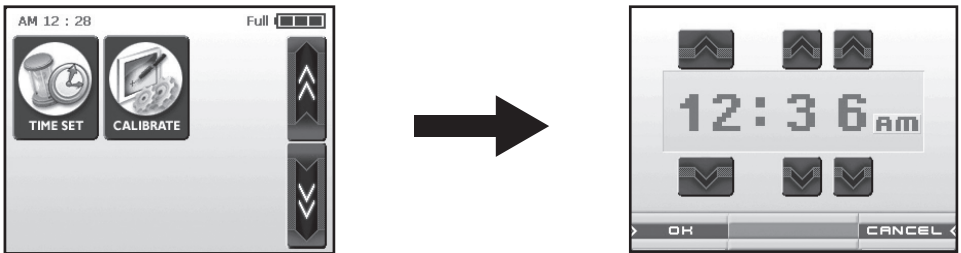

Calibrate

If the touch screen of your device is operating incorrectly, you can adjust it with the 'CALIBRATE' mode. Touch the 'CALIBRATE' icon on the main menu screen. See page 7 for additional information on accessing the calibrate screen.

To begin the calibration, tap and hold the center of the target. When the target moves to another position, tap and hold again. Repeat the same step to complete the adjustment. Once the calibration is complete, a new screen with a message reading "New calibration settings have been measured" will appear. If you want to keep the changed settings, tap the screen, or press the NavAtlas button located on the front to return to the main menu.





Transferring Files

Using Microsoft® ActiveSync® with the USB Cable

You will need to install the included Microsoft ActiveSync software on a PC in order to transfer maps, music, or movie files onto the SD card. Insert the Microsoft ActiveSync disc in your PC and follow the on-screen instructions.

Next, connect the mini-USB end of the USB cable to the mini USB connector located at the top left rear side, and the other end to a USB port on your computer. Make sure ActiveSync is running and press the sync button at the bottom left to synchronize the XNAV3500P to your PC.

Browse to the SD storage card by going to [My Computer], [Mobile Device] and finally [Storage Card]. Select and copy your desired files/folders from your PC to [My Computer]-[Mobile Device]-[Storage Card].

My Computer

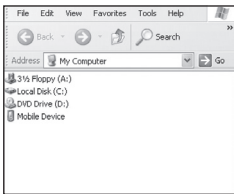

Mobile Device

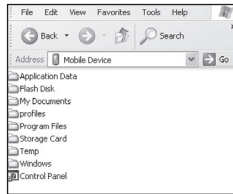

Storage Card



Visit the Microsoft website for more information at:
www.microsoft.com/windowsmobile/downloads/activesync37.mspx

Using an SD Card Reader (not included)

Insert the SD memory card into an SD card reader. Once the SD reader recognizes your SD card, move the desired files/folders to the SD card. Refer to the instructions provided with your SD card reader for more information.

Pre-Loaded Map Regions

Your XNAV3500P includes the following map regions pre-loaded on the included SD Card.



Major 1	Major 2	Major 3	Major 4	Major 5	Major 6
Washington	Minnesota	Alabama	West Virginia	Maryland	New York
Oregon	Iowa	Mississippi	Michigan	Virginia	Connecticut
California	Nebraska	Louisiana	Ohio	District of Columbia	Rhode Island
Nevada	South Dakota	Arkansas	Indiana	North Carolina	New Jersey
Arizona	North Dakota	Oklahoma	Kentucky	South Carolina	Pennsylvania
	Montana	Texas	Pennsylvania	Georgia	Massachusetts
	Wyoming	New Mexico	Tennessee	Florida	Vermont
	Idaho			Delaware	Maine
	Colorado				New Hampshire
	Utah				Delaware
	Wisconsin				
	Illinois				
	Missouri				
	Kansas				
	Oklahoma				

Operating the Navigation Software

Hardware Keys



Zoom in/Zoom out key – Functions only in map view mode.



Volume control – Rotate the control upward to increase the volume; downward to decrease.

Software keyboard

A software keyboard appears at the bottom of the screen when text entries are necessary. Only capital letters can be entered.

Keyboard entries – You can carry out all entries by tapping with the stylus or your finger on the software keyboard.

Switching between character and number entry – Tap the icon  to enter numbers (for example, a zipcode). Tap the  icon to return to the character entry mode.

Enter a space character, delete a single character – Tap the  key to insert a space character; tap the  key to delete the character to the left of the insertion mark.

Special characters – When you tap a key, a line above the software keyboard appears that lists all characters that may be entered by this key. The active character is highlighted.

Moving the cursor – To delete a character other than the one to the left of the cursor position, or insert a character at a place other than at the end of the text, move the cursor by tapping the location where you want it.

Command buttons

Icons – The following buttons appear at the right of every navigation screen:



Return – Tap this icon to return to the previous screen.
This icon is not available on the Main Screen.



Main Screen – Tap this icon to open the main screen.
This icon is not available on the Main Screen.



Global Positioning Satellite Status Icon and Screen

GPS – The GPS symbol is placed at the top right corner of the screen.

The color of this icon and the number displayed have the following significance:

Red – A GPS receiver is not connected or the power supply is interrupted.

Orange + number of received satellites – A GPS receiver is connected, but the received signals are not strong enough for navigation purposes (for example, inside a tunnel).

Green + number of received satellites – Strong signal: navigation may begin.

Tap the **GPS** icon to display the current GPS status:

GMT – Greenwich Mean Time (time in London, without daylight saving time).

Longitude /Latitude – current position; indication of east longitude and north latitude.

Satellites – Number of received satellites. At least three satellites must be received for navigation purposes.

HDOP – Horizontal Dilution of Precision indicates the quality of position determination. Theoretically, any value from 0 to 50 can occur. The smaller the value, the more accurate the position.

Speed – Indicates your vehicle's current speed.

Position – Indicates the address of your current position.

Save – Tap this button to add the current address to the saved destinations list.

Quit – Tap this button to exit navigation and return to the Main Menu Screen.

Command Buttons with Caption

Command buttons – You will find command buttons with captions on almost every screen.

There are three groups of command buttons:

1. **Command buttons with a defined functionality.** These buttons are designed to execute a functionality, which is indicated by their caption: **Save, OK, Cancel, Select map, One destination**, etc.
2. **Buttons to select one of two functions.** Use these buttons to select one of two options. The current state is indicated by the caption of the button: **User mode, Yes-No, On-Off**. When you tap one of these buttons, the caption switches to the other function. Confirm this change by clicking another button (**OK** or **Save**) before the current screen closes.
3. **Buttons to enter data.** These buttons will be referred to as entry fields throughout this guide. The caption is either your last entry or **<please select>**: **City, Street, Category** (of a POI), etc. When you tap an entry field, another screen with a software keyboard, a list, or both opens where you can make entries. Confirm this entry by clicking another button (**OK** or **Save**) before the entry screen closes. Your entry then becomes the caption of the entry field.

IMPORTANT NOTE: When turned on for the first time (or if the unit has been idle for several days, or been moved more than 250 miles while off), it can take several minutes to acquire a GPS signal.

GPS signal acquisition times will be typically less than a minute when the unit is turned on again.

A Note on Standard Mode:

Standard mode is the default, and provides reduced functionality to allow quicker access to simple operations. Work in Standard mode if you do not need such functions as Route Planning, or indicating a destination on the map. These Quick Start Guide instructions are for Standard mode only. For detailed navigation functions and Extended mode operation, please refer to the full-length owner's manual included in .pdf format on the DVD-ROM.

Starting Navigation

Initial Operation:

1. Turn on the XNAV3500P. Tap the NAVI icon.
The navigation software will load in approx. 25 seconds. The first time you select the NAVI icon the following safety message will appear:

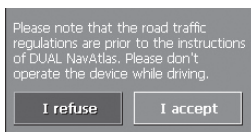

2. Tap the **I accept** button. If you tap the **I refuse** button, the unit will return to the main menu. If you select **I accept**, the "select navigation map" screen will appear:



3. Select **Yes**; the available navigation maps will appear (based on the maps currently loaded on the SD card). Select the desired major map region (see page 13-14 for additional details on major map regions).



4. Tap **Ok**. When the selected map region is loaded, the **MAIN SCREEN** appears.



Subsequent Operation

At each subsequent navigation software launch, the following safety message appears:

Please note that the road traffic regulations are prior to the instructions of DUAL NavAtlas. Please don't operate the device while driving.

I refuse

I accept

Note: When you turn the unit on by using the power button, it shows the screen which was displayed when the unit was last turned off. You can still access the Main Screen from all other screens by tapping:

New destination – Tap this button to indicate a destination for navigation.

Navigate home – Tap the Home button to navigate to your home address. NOTE: To enter your home address, go to the SETTINGS screen.

Saved destinations – Tap the Saved destinations button to select a saved destination.

Recent destinations – Tap the Recent destinations button to select a recent destination.

Select map – Tap the Map button to select another map from the memory card.

Settings – Tap this button to modify the settings.

Quit – Tap this button to quit navigating and return to the XNAV3500P main menu.

Entering a Destination

In the MAIN MENU, tap New destination. The DESTINATION screen appears:

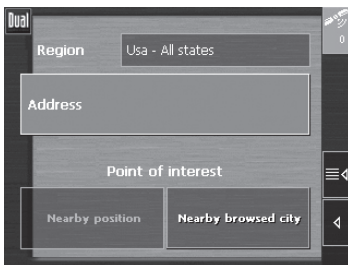

Tap the **Region** entry field and select the destination state or province/territory.

Note: Only states that are at least partly represented on the currently loaded map can be selected.

Entering an Address

1. In the **DESTINATION** screen, tap **Address**. The **ADDRESS** screen appears.



2. Enter the name of the destination city into the **City/ZIP** entry field. For cities in the United States you may also enter the Zip code. Press **Ok** to confirm.
3. Enter the destination street into the **Street** entry field. Press **Ok** to confirm.
4. Enter a house number into the House number field at the right hand side of the street if possible. **Note:** You do not need to enter a street suffix, or a street type to get a search result. For example, if you are looking for a street called “S Main Avenue”, simply type in “MAIN”. If the house numbers of the selected street are stored in the database, you may tap the field next to the Street field. If the house numbers are not stored in the database, the necessary field will be deactivated, and the software will navigate to the selected street. Press **Ok** to confirm.
5. Enter the name of a crossroad into the **Intersection** entry field if you want to define an intersection as a destination point (e.g., because the house number is not available). Enter the name of a crossroad into the Intersection entry field. Press **Ok** to confirm.

Selecting a Point of Interest

Points of Interest – also referred to as POIs – are stored in the database of places and may be displayed on the map. Ports, airports, restaurants, hotels, gas stations, public buildings and others are considered Points of Interest. They may be selected as destinations for navigation purposes.

Point of Interest - Nearby Position

Important Note: You may only select points of interest nearby position when the GPS signal strength is sufficient.

1. On the **DESTINATION** screen, tap **Nearby position**. The **POI NEARBY** screen appears.



Selecting a Point of Interest - Nearby Position



2. Enter the radius around your current position in which you want to search for points of interest into the **Radius** entry field.
3. Select the main category of points of interest to search for from the left of the two **Category** list fields, e.g., "Garage". Only points of interest situated within the indicated radius will be displayed.
4. Select the **Subcategory** of points of interest to search for from the right of the two **Category** list fields. **Note:** If you leave the **Subcategory** field empty, all points of interest matching with the selected main category will be listed in the **Point of Interest** list field.
5. Select the correct destination from the **Point of Interest** list field.

Point of Interest in Another City

1. On the **DESTINATION** screen, tap **Nearby browsed city**.
The **NEARBY CURRENT GPS** screen appears.



2. Enter the name of the city in which you want to search for points of interest into the **City** field.
 3. Select the main category of points of interest to search for from the **Category** list field (e.g., Culture). Only categories matching your City entry are listed.
 4. Select the **Subcategory** of points of interest (to the right of the **Category**) to search for one of the subcategories of the two **Category** list fields (e.g., Museum).
 5. Select the desired destination from the **Point of Interest** list field.
- Note:** You do not need to make entries into the **Category** and **Subcategory** fields. Their purpose is only to shorten the **Point of Interest** list. This list may become extensive, especially in major cities.

Starting Navigation

1. Enter a destination.
2. Tap Start navigation. The system calculates the route. The map screen appears. Your current position is indicated by a red arrow. The route is highlighted in green.

Note: Navigation will start automatically when a GPS signal is available.

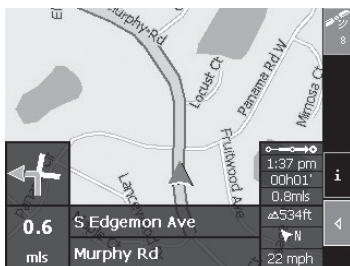

Note: When you start navigation after having planned or loaded an itinerary, your current position is the start point of the route. The first indicated route point is then the first stage point of your route.

Working with the Map

Selecting a map

The included DVD-ROM contains additional US maps as well as Canada and Hawaii. To use these maps, copy them to the SD memory card by means of a card reader or by using ActiveSync software. Refer to page 12 for more details.

To load a map region that is not available on the currently inserted memory card, proceed as follows:

1. Go to the **MAIN SCREEN** and tap the **Quit** button. The main menu screen appears.



2. Remove the SD memory card. Load new maps using an SD card reader, or use Microsoft ActiveSync.
3. Insert the memory card containing the desired map and press RESET on the unit.
4. From the main manu screen, tap the **NAVI** icon to begin.

Working with the Map

To load a map that is on the currently inserted memory card, proceed as follows:

1. From the the **MAIN SCREEN**, tap the **Map** button. The **AVAILABLE MAPS** screen appears:



2. Tap the desired map, then tap **Ok**.

3. The unit will prompt for a restart anytime maps are changed. Tap **OK**.

After the selected map is loaded, the **main menu** appears. Tap the **NAVI** icon to begin.

Icons

The following icons are displayed on the map:

Tap the **Zoom/Scroll** icon or to switch between Zoom and Scroll mode.

Zoom

In Zoom mode (the icon appears white) you may scale the map size up or down. Zoom in by selecting a rectangular area on the map, beginning with the upper left corner. Zoom out by beginning with the lower right corner.

Scrolling

In Scroll mode (the icon appears red) you may scroll the map. Tap on the screen and drag to the desired direction.

Itinerary planning

This icon is active when a calculated itinerary is loaded. Tap the **Itinerary** icon to display the whole itinerary. Tapping this icon again will display the previous map view.

Map in driving direction/north oriented

Tap the In driving direction/North oriented icon / to switch between the two available modes of map orientation (North orientation or orientation in driving direction).

North orientation

Tap this icon to orientate the map north up (the icon appears white).

In driving direction

Tap this icon to orientate the map in driving direction (the icon appears red).

Working with the Map

3D view (GPS signal necessary)



Tap the **3D** icon to display the map in 3D mode. The icon becomes the 2D icon. Tap the **2D** icon to return to the 2D mode (standard). The icon becomes the 3D icon.

Center (GPS signal necessary)



Tap the **Center** icon to center your current position on the map.



Zoom bar

Tap one of the zoom bar segments or use the zoom in/out button to modify the scale of the map.

Auto mode (GPS signal necessary)

AUTO

Tap the **Auto** icon to display the standard representation of the map after you have modified the view. The settings of North orientation and auto zoom mode will be applied. Your current position will be centered. The icons will autohide. Tap anywhere on the screen to reveal the icons and resume manual display mode.

Selecting an entry from a list

There are many situations in which it is necessary to select an entry from a list. For example, if you have not completely entered the name of a city before tapping **OK**, a list appears that contains all cities beginning with your entry or including it in the name. The postcode of the cities is also indicated in order to allow you to choose the correct one if there is more than one city with the same name.

Highlighted entry

One of the entries is highlighted as the focus. This entry is written in bold and is positioned more at the left than the other entries of the list. There may be additional information on the entry listed underneath. The list of cities includes the county of each entry.

Icons

At the right hand side of lists, there are three icons:

 **OK:** Tap this icon to confirm the selection of the highlighted entry (placed directly at the left of the OK icon).

 **Up:** Tap this icon to scroll the list one item up.

 **Down:** Tap this icon to scroll the list one item down.

Working with the Map - Searching for an Address

Example: Search for **ORLANDO**.

1. In the **MAIN MENU** tap **New destination**. The **DESTINATION** screen appears.
2. Tap **Address**. The **ADDRESS** screen appears.
3. Tap the **City/ZIP** entry field. The software keyboard appears, and the cursor is blinking in an empty entry field.



4. Enter the letters **OR**.

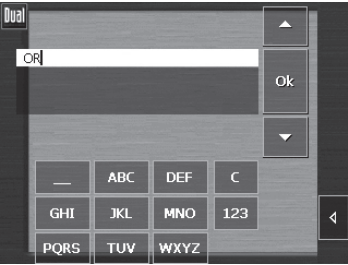

5. Tap **Ok**. All cities beginning with **OR** or having **OR** in their names are listed.

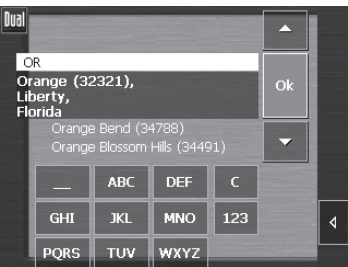

Working with the Map - Searching for an Address

6. When the list is very long, you may enter one more letters in order to shorten the list.
Enter L.



7. Tap **OK**. All cities beginning with ORL or having ORL in their name are listed. Tap the **Down** icon repeatedly until **ORLANDO** appears directly under the white entry field. The entry **ORLANDO** is highlighted.

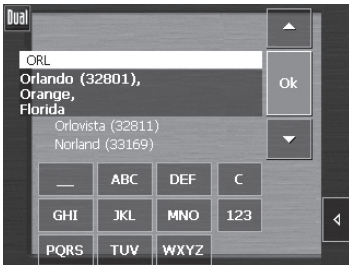

8. Tap **OK**. The **ADDRESS** screen reappears. **32801 Orlando** is entered into the **City/ZIP** field.
9. Enter the desired street and/or house number or, press **Start Navigation** to begin navigating.

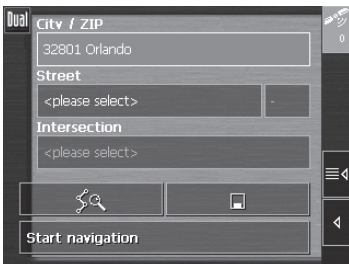





Additional Functions

In map view mode, tap the  icon to display the **ADDITIONAL FUNCTIONS** screen. The availability of some functions depends on whether you are navigating or not.

The **ADDITIONAL FUNCTIONS** screen appears:



-  Tap the **Day** icon to adjust the brightness of the screen to daylight conditions.
-  Tap the **Night** icon to adjust the brightness of the screen to night conditions.
-  Tap the **Speaker Mute** icon to mute the audio.
-  Tap the **Speaker** icon again to resume audio.

Additional Functions - Map Display in Navigation Mode

Navigation mode provides assistance for navigation, itinerary information and display of an additional command button.

The following assistance for navigation is displayed at the left and at the bottom of the map:

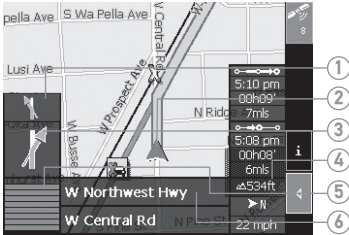

Field Information

1. If there are two maneuvers to be executed quickly one after the other, the small upper arrow field indicates the maneuver to be executed immediately after the first maneuver.
2. The red arrow indicates your current position on the map. Because the displayed sector of the map constantly changes, your current position is centered on the map whenever possible (moving map).
3. The larger arrow field indicates the next maneuver to be executed.
4. The distance field indicates the distance to the next maneuver. When you approach, the representations change into a distance bar:



5. The greater the number of bars that are displayed, the closer you are to the place where the next maneuver must be executed.
6. The upper street field indicates the name of the next street to turn on.
7. The lower street field indicates the name of the street you are currently on.

Information on the Itinerary

At the right of the map, the following information on the itinerary is displayed:



Field information



This symbol means "stage." All information displayed below refers to the next stage point.



ETA (Estimated Time of Arrival).



Remaining time to arrival (estimated).



Remaining distance to arrival (estimated).



Tap this icon to repeat the last spoken instruction. All available information will be displayed.



Limited One-Year Warranty

This warranty gives you specific legal rights. You may also have other rights which vary from state to state.

Dual Electronics Corp. warrants this product to the original purchaser to be free from defects in material and workmanship, under normal conditions, for a period of one year from the date of the original purchase.

Dual Electronics Corp. agrees, at our option, during the warranty period, to repair any defect in material or workmanship or to furnish an equal new or renewed product in exchange without charges, subject to verification of the defect or malfunction and proof of the date of purchase.

During the One-Year Warranty Period:

For One Year from the date of purchase, your product will be replaced with a new, renewed or comparable product (whichever is deemed necessary) if it becomes defective or inoperative. This is done without charge to you. Replacement products are warranted for the balance of the original warranty period.

Who is covered? This warranty is extended to the original retail purchaser for products purchased and used in the U.S.A.

What is covered? This warranty covers all defects in material and workmanship in this product. The following are not covered: installation/removal costs, damage resulting from accident, misuse, abuse, neglect, product modification, improper installation, incorrect line voltage, unauthorized repair or failure to follow instructions supplied with the product, or damage occurring during return shipment of the product.

What to do?

1. Before you call for service, review your owner's manual. A slight adjustment of any custom controls or connections may save you a service call.
2. If you require service during the warranty period, you must carefully pack the product (preferably in the original package) and ship it by prepaid transportation with a copy of the original receipt from the retailer to an authorized service center.
3. Please describe your problem in writing and include your name, a return UPS shipping address (P.O. Box not acceptable), and a daytime phone number with your shipment.
4. For more information and for the location of the nearest authorized service center please contact us by one of the following methods:
 - Call us toll-free at 1-866-429-1628
 - Email us at cs@dualav.com

Exclusion of Certain Damages: This warranty is exclusive and in lieu of any and all other warranties, expressed or implied, including without limitation the implied warranties of merchantability and fitness for a particular purpose and any obligation, liability, right, claim or remedy in contract or tort, whether or not arising from the company's negligence, actual or imputed. No person or representative is authorized to assume for the company any other liability in connection with the sale of this product. In no event shall the company be liable for indirect, incidental or consequential damages.

Battery Specifications/Charging

Battery Capacity		1500mAh	
Full Charge Time		3.5hrs	
Approximate Lifespan	More Than 80% Discharged	Avg. 300 Times	
	Less Than 50% Discharged	Avg. 500 Times	
Approximate Time	Maximum Brightness	Navigation	3.0hrs
		Playing Audio	3.0hrs
		Playing Video	2.5hrs
		Menu Screen	4.0hrs
	Minimum Brightness	Navigation	4.0hrs
		Playing Audio	4.0hrs
		Playing Video	3.5hrs
		Menu Screen	6.0hrs
Sleep Mode (Power Off)		Avg. 12 days	

System Reset

Occasionally, your system may appear to stop responding or be “locked up”. To reset your system, press the reset button on the left side of your device. Your system will reboot and operation should return to normal. Resetting your system is similar to restarting a computer. If the problem still appears after resetting the unit, please contact technical support for further assistance.

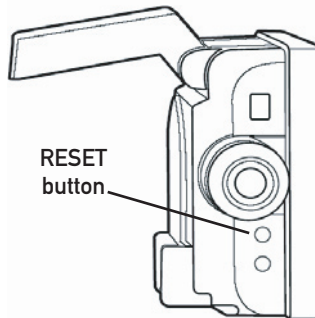



XNAV3500P PORTABLE GPS NAVIGATION SYSTEM

Specifications

Display	Size: 3.5" (88.9 mm) diagonal measurement Format: Standard 4:3 View area: 2.76" W 2.07" H (70 x 52.5 mm) Display system: Transmissive TFT LCD panel Resolution: 320RGB x 240 Elements: 76,800 Brightness: (cd/m ²): 250 Contrast ratio: 300:1 Colors: 16.7M
General	Operating voltage: 12VDC DC adapter fuse rating: 3A Antenna system: 12 channel parallel GPS Memory interface: SD card slot Unit dimensions: 5.1" W x 3.2" H x 2.1" D Weight: 9.5 ounces Battery: Internal lithium ion

Dual Electronics Corporation
Technical Support: 1-866-429-1628
www.dualav.com
NSA0605-V03

Quick Start Guide Version 3.0
Copyright© 2005 All rights reserved.
©2005 NAVTECH All rights reserved.
Design and specifications subject to change without notice.

Microsoft® and ActiveSync® are registered trademarks of Microsoft Corporation
in the United States and or other countries.

This document and the software described in it are furnished under license and may be used or copied only in accordance with such license. Except as permitted by such license, the contents of this document may not be disclosed to third parties, copied, or duplicated in any form, in whole or in part, without the prior written permission of Dual Electronics, Inc.
